

# Pre-delivery guide

## Oasis

Get ready to welcome  
your new spa cover

**COVANA**

This comprehensive guide will help you prepare for the arrival and installation of your Covana automated spa cover. From selecting the ideal location to planning the delivery, each section offers tips for a safe and easy installation.

Use the table of contents to easily navigate the guide and optimize your experience.

## Table of contents

CHOOSING THE PERFECT LOCATION.....	3
HOT TUB COMPATIBILITY.....	4
COLORS.....	6
PRIVACY SHADES - OASIS STANDARD & MIDNIGHT.....	7
PRIVACY SHADES - OASIS MIDNIGHT PLUS.....	8
PRIVACY SHADES - OASIS MIDNIGHT XL.....	9
LAYING THE RIGHT FOUNDATION.....	10
OPTION A - GROUND ANCHORING.....	10
OPTION B - NON-PERMANENT MOUNTING PLATES.....	11
ELECTRICAL SPECIFICATIONS.....	12
PLANNING THE DELIVERY.....	13

To get the most out of your Covana spa cover and ensure its longevity, it all starts with choosing the right location.

## CHOOSING THE PERFECT LOCATION

- 1 The Covana cover can be installed either indoors or outdoors.
- 2 Away from flood zone, water downpours or debris falling.
- 3 Wind speed should not exceed 30 mph (50 km/h) in the raised position.
- 4 Operating area must be free from obstacles, i.e., branches or electrical power lines.
- 5 Allow for safe access to the spa, free of obstacles or debris.
- 6 Sunlight must not converge or be directly reflected on the cover such as the reflection from a window.
- 7 The installation area must be clean and free of any vegetation (i.e., grass, branches, roots) and mineral contaminants (i.e., rocks, dust, sand).
- 8 The key switch must be permanently mounted vertically and located 5 ft (1.5 m) away from the spa and 5 ft (1.5 m) above the deck or ground level in a location where no water downpour or debris could fall on it.
- 9 The user must have a clear view of the cover when operating it (25 ft / 7.6 m cable).

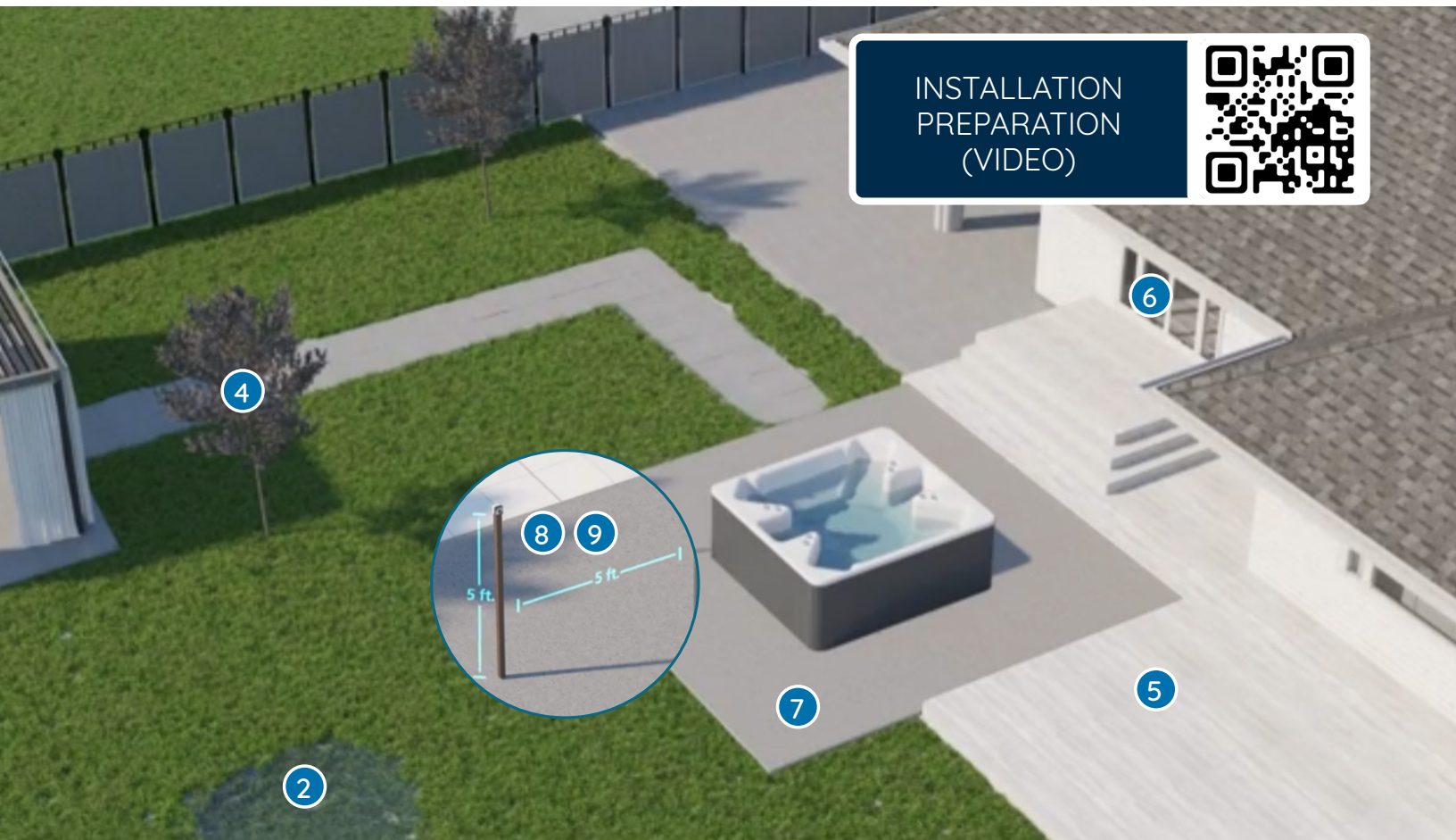

If you are unsure which model to choose, please go to:  
[covana.com/en/support](http://covana.com/en/support)

## HOT TUB COMPATIBILITY

Most square, rectangular, or round hot tubs with a flat surface (no protruding headrests) of up to 92.75 in x 98 in (235.5 cm x 249 cm - Std and Midnight), 92.75 in x 101 in (235.5 cm x 256.5 cm - XL), 98 in x 96 in (249 cm x 244 cm - PLUS) with a height between 34 in and 48 in (86 cm x 122 cm).

The dimensions of the Standard (Std), Midnight PLUS, and Midnight XL models are illustrated below. The dashed line dimensions include the recommended clearance for maintenance.

It is important to consider the location of the entrance when choosing between the different models.

	STD	PLUS	XL
1	52 in (132 cm)	57 in (145 cm)	*
2	98 in (249 cm)	96 in (244 cm)	101 in (256.5 cm)
3	92.75 in (235.5 cm)	98 in (249 cm)	92.75 in (235.5 cm)



MODEL	<input checked="" type="checkbox"/>
Standard	<input type="checkbox"/>
Midnight PLUS	<input type="checkbox"/>
Midnight XL	<input type="checkbox"/>

\* The Oasis Midnight XL is equipped with a full bottom U-frame at the front; therefore it does not include a U-plate entrance for steps.

## HOT TUB COMPATIBILITY (CONTINUED)

The seal of the cover will have to be installed on a flat surface on the acrylic of the hot tub. The minimum turn radius of the seal is 4 in (10 cm). Ensure the seal will be able to go all around the hot tub while continuously touching the inner shell.

The colored area illustrated below is where the seal must be applied. Therefore, it will be impossible to apply the seal on an area smaller than 65 in x 70 in (165 cm x 178 cm).

4	92 in (234 cm)
5	98 in (249 cm)
6	65 in (165 cm)
7	70 in (178 cm)

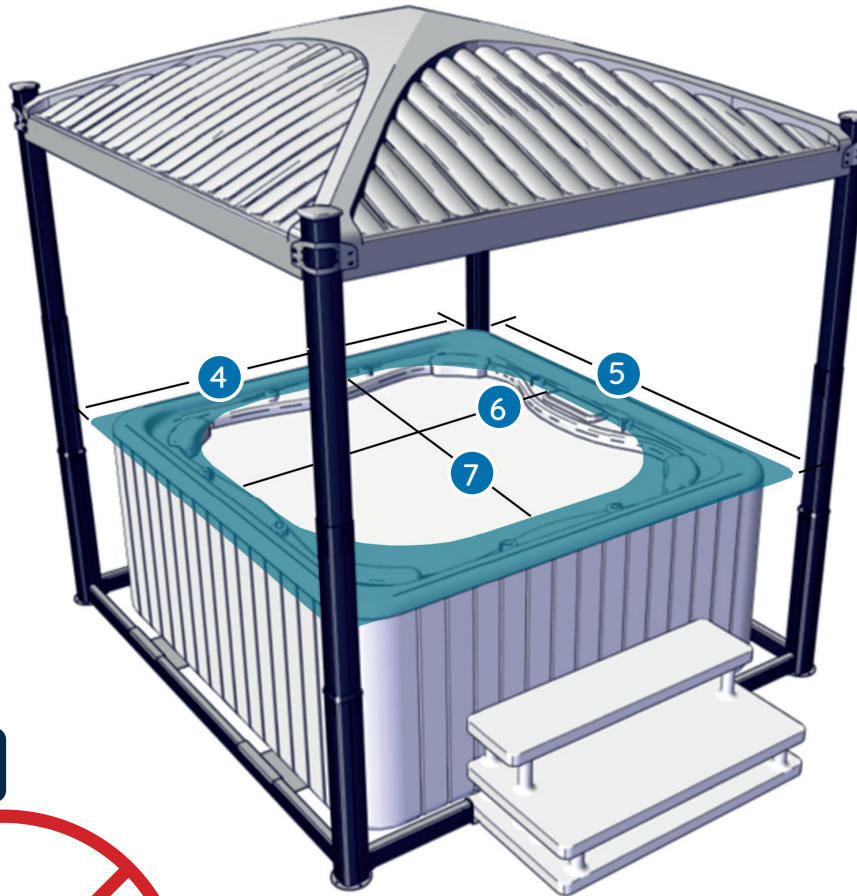

No protruding  
headrests



Choose the color that will perfectly match your environment.

## COLORS

(Actual colors may vary from images shown.)



Mocha



Slate

COLOR	<input checked="" type="checkbox"/>
Mocha	<input type="checkbox"/>
Slate	<input type="checkbox"/>
Black	<input type="checkbox"/>

The Oasis Midnight, Midnight PLUS, and Midnight XL are offered exclusively in black.



Black

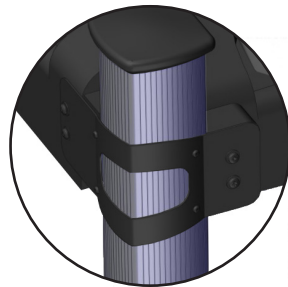

Midnight PLUS  
Midnight XL



Each Oasis cover is equipped with integrated LED mood lighting designed to create ambiance, warmth and a cozy atmosphere, with a choice of seven colors.

Discover our selection of shades designed especially for the Covana Oasis. Choose from different levels of opacity and enjoy your hot tub in complete privacy.

## PRIVACY SHADES - OASIS STANDARD & MIDNIGHT

### ENTRANCE, MOTOR, SIDES

 Opaque

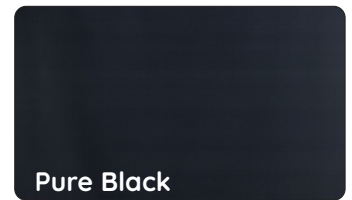
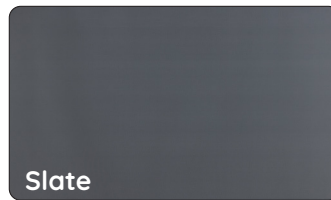
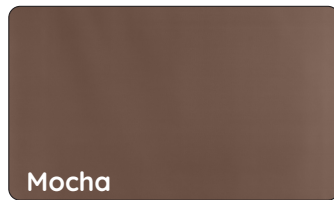

### ENTRANCE, MOTOR, SIDES

 Semi-opaque

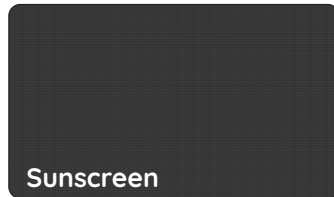
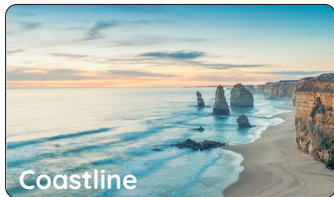

### ENTRANCE AND MOTOR ONLY

 Semi-opaque



MODEL	ENTRANCE	MOTOR	SIDE
Rockies			
Rainforest			
Island			
Mocha			
Slate			
Pure Black			
Coastline			
Sunscreen			
Blue Velvet			N/A
Seashore			N/A



**ENTRANCE, MOTOR, SIDES**

 Opaque

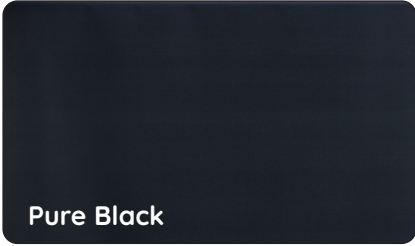

**ENTRANCE, MOTOR, SIDES**

 Semi-opaque



**ENTRANCE & MOTOR ONLY**

 Semi-opaque



 Opaque



MODEL	ENTRANCE	MOTOR	SIDE
Rockies			
Island			
Pure Black			
Sunscreen			
Coastline			N/A
Slate			N/A

**NOTE**

The roller shades for the **sides** of the unit come with a longer rod to accommodate the 96-inch (244 cm) length.

Note that there will be approximately a 4-inch (10 cm) gap on each side of the roller shade (long sides only).

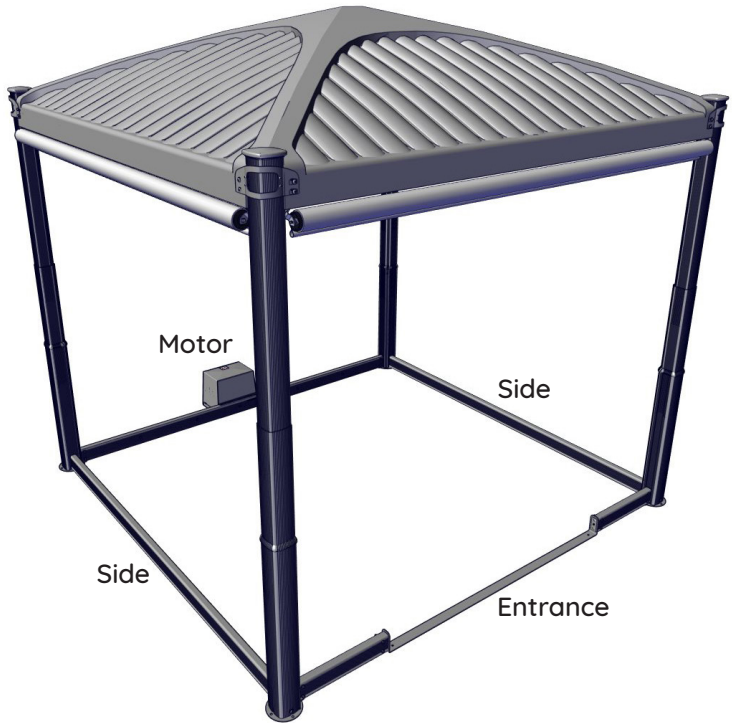

### FRONT, REAR, SIDES

 Opaque			 Semi-opaque	
 <p>Rockies</p>	 <p>Island</p>	 <p>Pure Black</p>	 <p>Sunscreen</p>	

### FRONT & REAR ONLY

 Semi-opaque			 Opaque	
 <p>Coastline</p>	 <p>Seashore</p>	 <p>Blue Velvet</p>	 <p>Slate</p>	

MODEL	FRONT	REAR	SIDE
Rockies			
Island			
Pure Black			
Sunscreen			
Coastline			N/A
Seashore			N/A
Blue Velvet			N/A
Slate			N/A

**NOTE**

The roller shades for the **sides** of the unit come with a longer rod to accommodate the 101-inch (257 cm) length.

Note that there will be approximately a 4-inch (10 cm) gap on each side of the roller shade (long sides only).

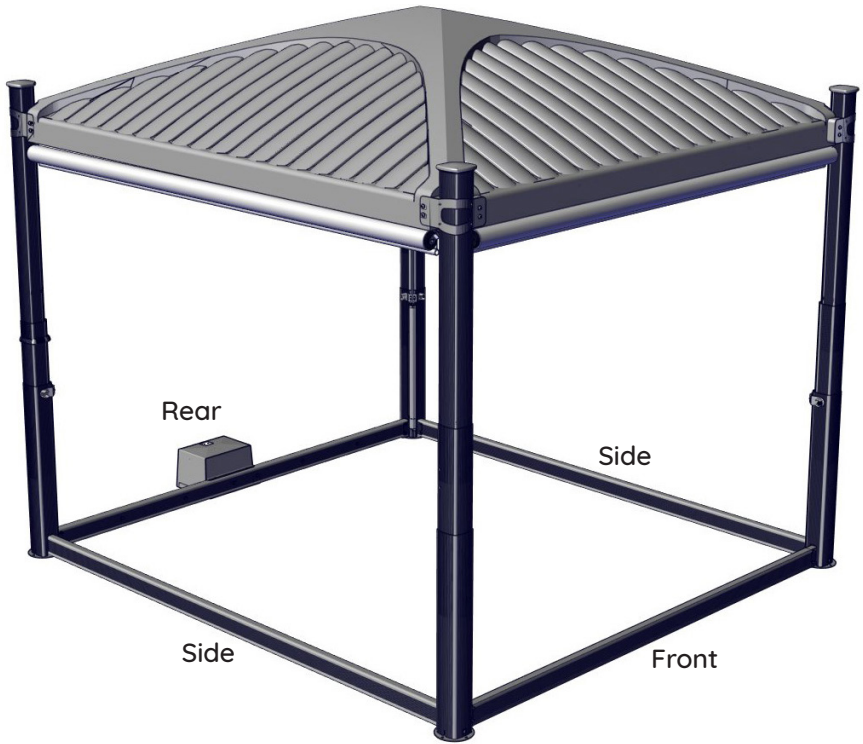

To ensure the stability and proper functioning of your Covana cover, an adequate foundation is essential.

## LAYING THE RIGHT FOUNDATION

- A clean, flat and level surface such as an engineered wood deck or a concrete slab is needed.
- The foundation must be able to support at least 600 lb (272 kg).
- Ideally, the cover should be installed on the spa foundation.
- Any water accumulating around the cover will have to be drained.
- Allow for at least 24 in (60 cm) of clearance for maintenance on the motor and entrance sides, and 6 in (15 cm) on the other sides.
- The four jacks will have to be properly anchored to the foundation (anchors not included).

### OPTION A - GROUND ANCHORING

#### MINIMUM BASE SIZE

Contact Covana if the foundation is already in place and its dimensions are smaller than those illustrated below.

	STD	PLUS	XL
1	106 in (269 cm)	112 in (284.5 cm)	106 in (269 cm)
2	118 in (300 cm)	116 in (295 cm)	121 in (307 cm)

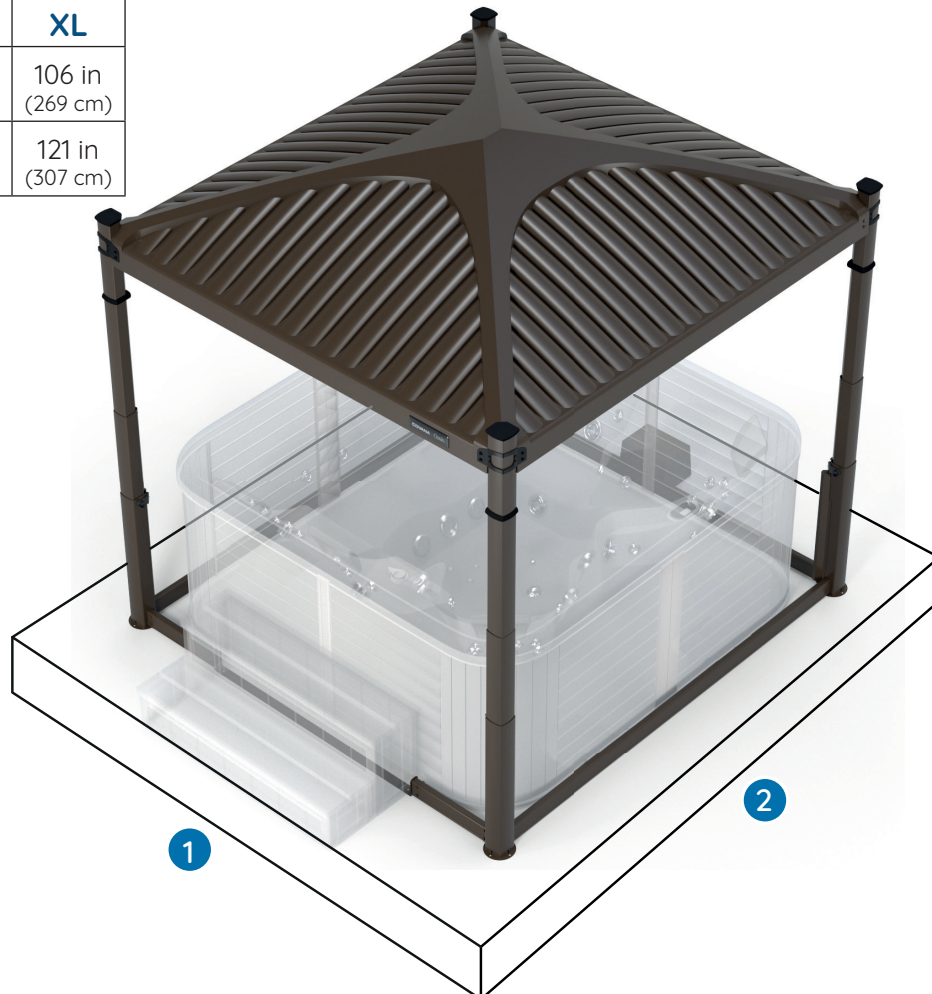

## OPTION B - NON-PERMANENT MOUNTING PLATES

If ground anchoring is not possible, use our non-permanent mounting plates, which offer a secure, drill-free fixing solution. These plates are suitable for spas wider than 82 inches (208 cm) for the Standard, Midnight and Midnight XL models. For the Midnight PLUS model, they are suitable for spas wider than 87 inches (221 cm).



For a safe and compliant installation, it is crucial to know the electrical specifications and follow the safety rules.

## ELECTRICAL SPECIFICATIONS

- All electrical work should be done by a certified electrician, otherwise the certification and warranty will be void.
- The cover requires a dedicated single-phase 115 VAC (North America) or 230 VAC (Europe) hard-wired power supply.
- The cover must be installed in accordance with and comply with all applicable local codes and regulations.
- Wires and conduits should be sized according to local codes and regulations.

### **NORTH AMERICAN REQUIREMENTS**

Voltage	115 V, 60 Hz (1 hot, 1 neutral, 1 ground)
GFCI	15 A single-pole GFCI (not included)
Current draw	Max 12 A

### **EUROPEAN REQUIREMENTS**

Voltage	230 V, 50 Hz (2 phases, 1 ground)
GFCI	10 A single-pole GFCI (not included)
Current draw	Max 6 A

To ensure a safe reception and a smooth installation, careful preparation is key.

## PLANNING THE DELIVERY

The Oasis cover will be delivered in a wooden crate. Take the time to sketch out a simple map from the delivery point to the installation point for the delivery personnel. You can also disassemble the unit from the crate at the delivery point and move the parts by hand.

NOTE: The largest and heaviest part will be the cover assembly weighing approximately 200 lb (90 kg).

1	106 in (269 cm)
2	103 in (262 cm)
3	101 in (256 cm)
4	24 in (61 cm)

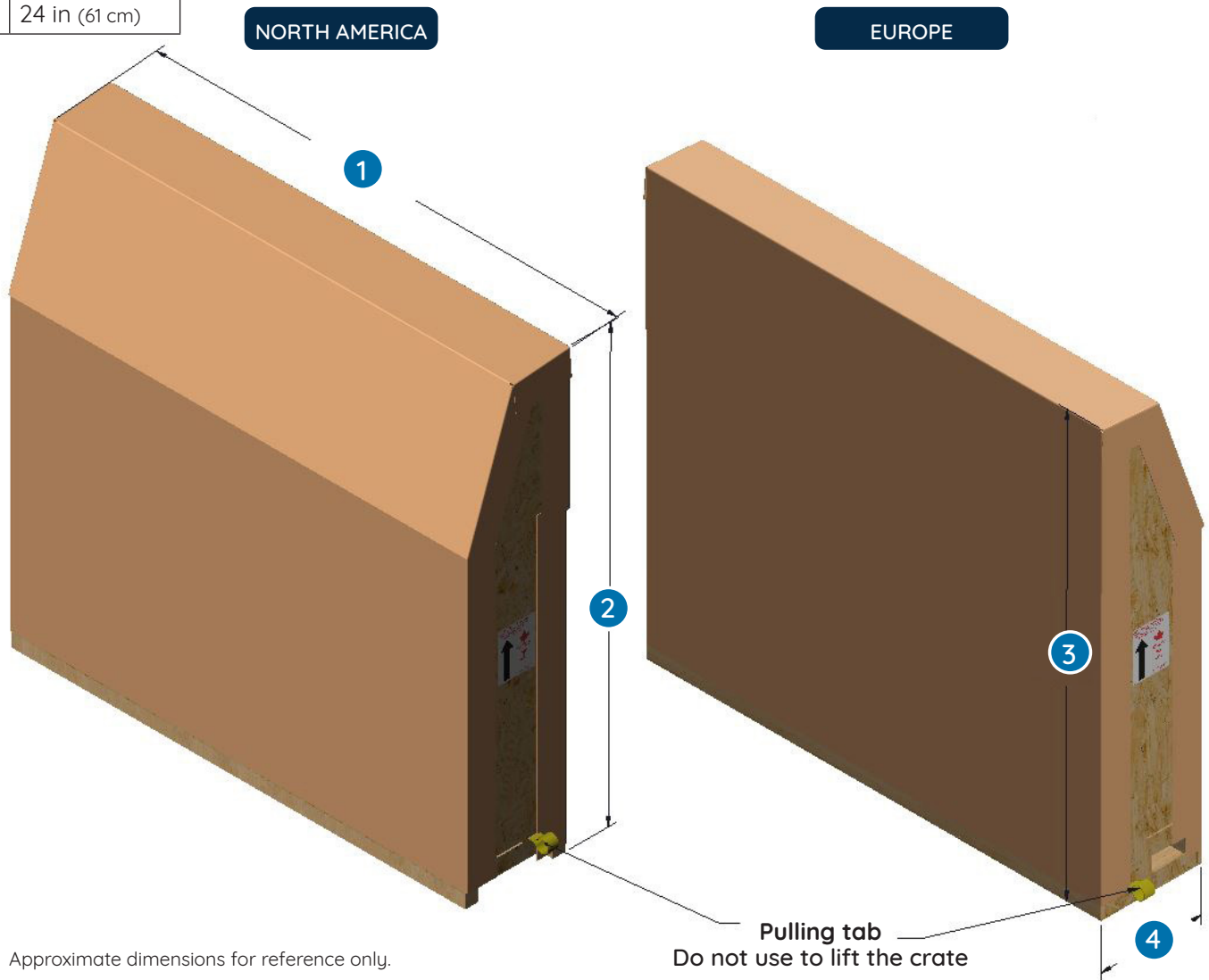



## USE THIS SIMPLE CHECKLIST TO PLAN THE DELIVERY ROUTE

- 1 Measure the width of stairs and steps to get up and over.
- 2 Are there railings in the way, and how wide apart are they?
- 3 Measure to see if shrubs or trees are an obstacle.
- 4 Ensure sidewalks are free of objects and clutter.
- 5 Check the doghouse or shed to see available clearance.
- 6 Check for uneven ground or slippery slopes.
- 7 Measure for overhanging gutters or downspouts.
- 8 Gate measurement for clearance.
- 9 Recreational vehicles and cars in the driveway?

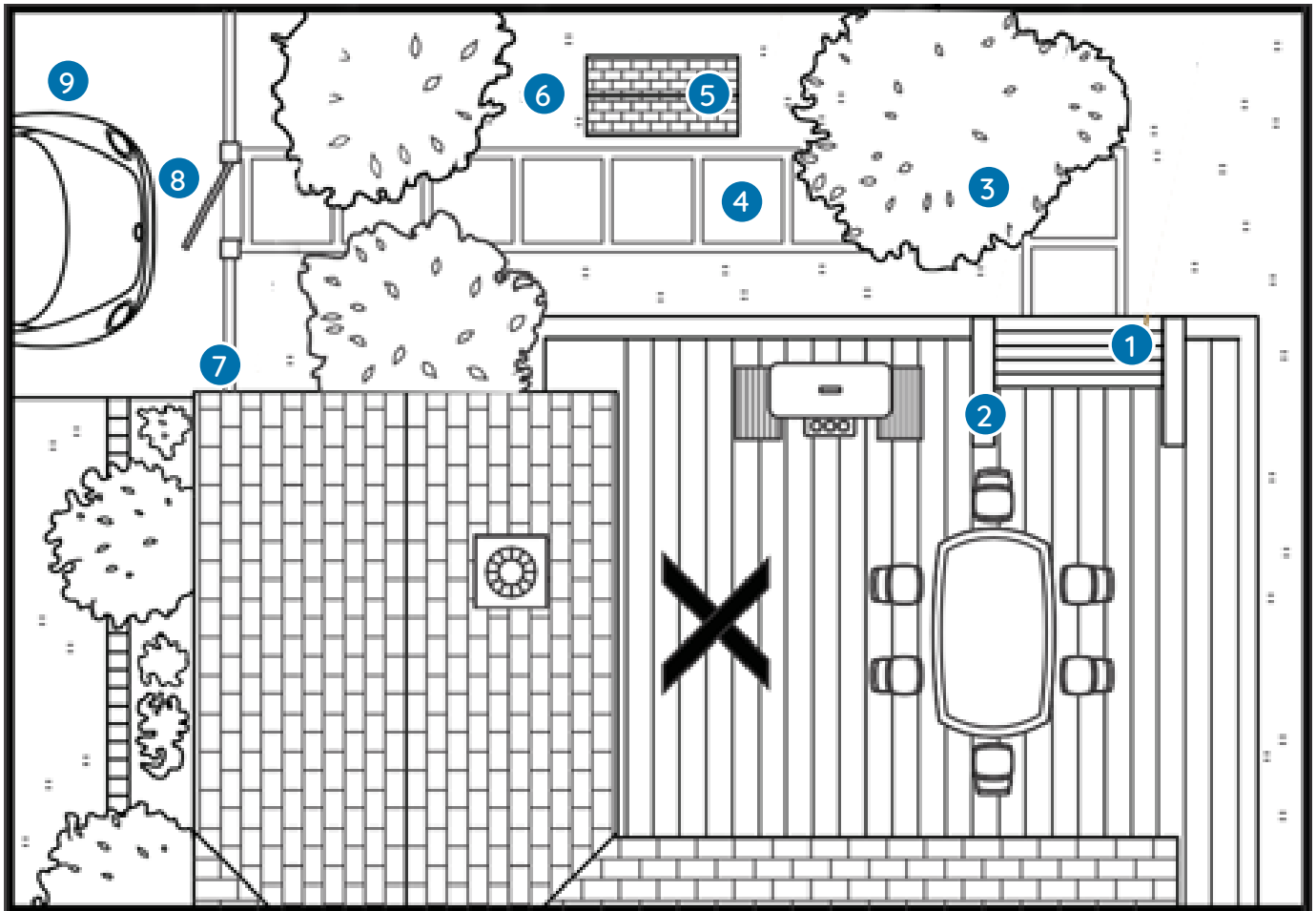



FOR MORE INFORMATION, AND TO FIND THE NEAREST  
COVANA RETAILER VISIT OUR WEBSITE:

[covana.com](http://covana.com)   [info@covana.com](mailto:info@covana.com)



COVANA a division of Canimex,  
committed to excellence since 1969.